



The purpose of stopper cylinders is to stop or block moving parts, such as load on an assembly line. They can also work as a stand-by stopping device, since they exploit the large diameter of the rod, using it as a pivot.

Le vérin stoppeur d'AIRWORK est utilisé pour arrêter ou bloquer un mouvement comme une charge sur une ligne de montage. Il peut aussi être utilisé comme butée et ce grâce à son diamètre de tige plus large.

I cilindri stopper hanno lo scopo di arrestare o bloccare parti in movimento, come i carichi all'interno di una linea di montaggio, oppure come blocco di stazionamento, sfruttando il grande diametro dello stelo utilizzandolo come perno.

ORDERING CODE / CODIFICATION / CHIAVE DI CODIFICA

ST 0 1 0 1 0 3 2 0 2 0

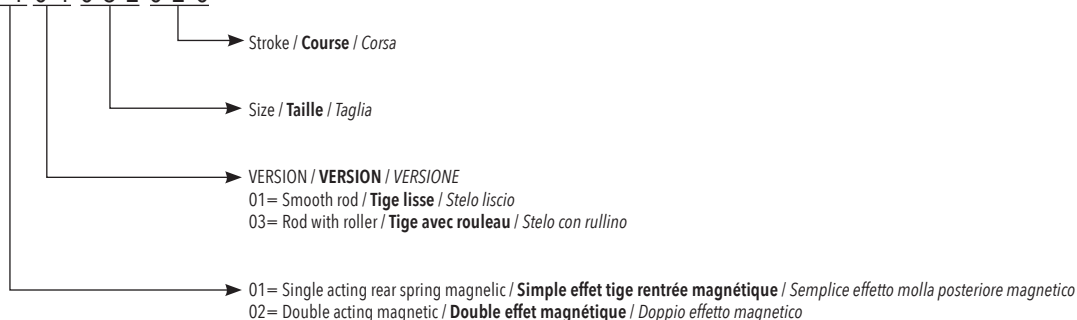

TECHNICAL DATA / DONNÉES TECHNIQUES / DATI TECNICI

Sizes / Alesages / Alesaggi	Ø32 - 50
Standard strokes / Course standard / Corse standard	Ø32x20 - Ø50x30
Fluid / Fluide / Fluido	Lubricated or non lubricated air / Air lubrifié ou non / Aria con o senza lubrificazione
Operating temperature range / Température d'utilisation / Temperatura di esercizio	-20°C / +80°C
Max operating pressure / Pression max d'utilisation / Pressione massima di esercizio	10 bar
Force / Force / Forze sviluppate	Technical informations page / Page informations techniques / Pagina dati tecnici
Air consumption / Consommation d'air / Consumo aria	Technical informations page / Page informations techniques / Pagina dati tecnici

COMPONENTS / COMPOSANTS / COMPONENTI

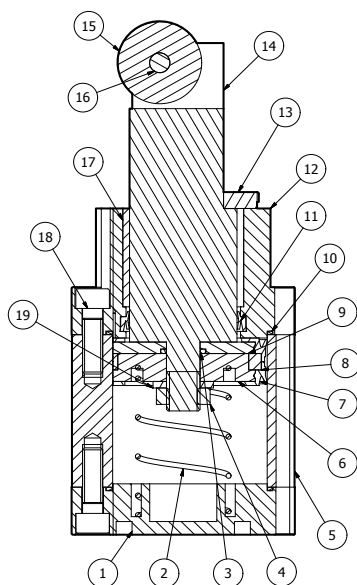

pos. description / description / descrizione	material / matière / materiale
1 rear cap / nez arrière / testata posteriore	aluminium / aluminium / alluminio
2 spring / ressort / molla	steel / acier / acciaio
3 o-ring / joint torique / O ring	NBR
4 nut / écrou / dado	steel / acier / acciaio
5 tube / tube / tubo	aluminium / aluminium / alluminio
6 piston / piston / pistone	aluminium / aluminium / alluminio
7 seal piston / joint piston / guarnizione pist.	polyurethane / polyuréthane / poliuretano
8 magnet / aimant / magnete	plastroferrite
9 piston / piston / pistone	aluminium / aluminium / alluminio
10 o-ring / joint torique / O ring	NBR
11 rod seal / joint de tige / guarnizione stelo	polyurethane / polyuréthane / poliuretano
12 front cap / nez avant / testata anteriore	aluminium / aluminium / alluminio
13 plate / plaquettes / piastrina	brass / laiton / ottone
14 rod / tige / stelo	s.s. AISI 304 / acier inox AISI 304 / acciaio inox AISI 304
15 roll / rouleau / rullino	steel C40 chromed / acier C40 chromé / acciaio C40 cro
17 guide bush / bague guidage / bussola guida	PTFE
18 screws / vis / viti	steel / acier / acciaio
19 washer / rondelle / acciaio	steel / acier / acciaio

LOAD DIAGRAM / **DIAGRAMME DE CHARGE** / *DIAGRAMMA DI CARICO*

Smooth rod / **Tige lisse** / *Stelo liscio*

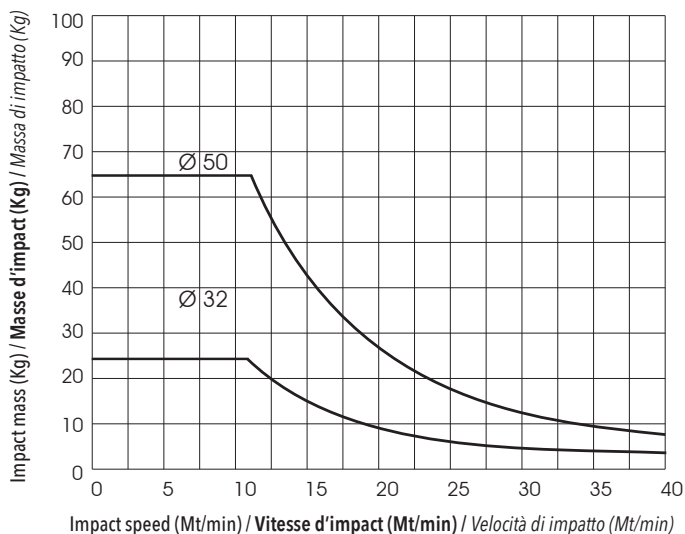

Rod with roller / **Tige avec rouleau** / *Stelo con rullino*

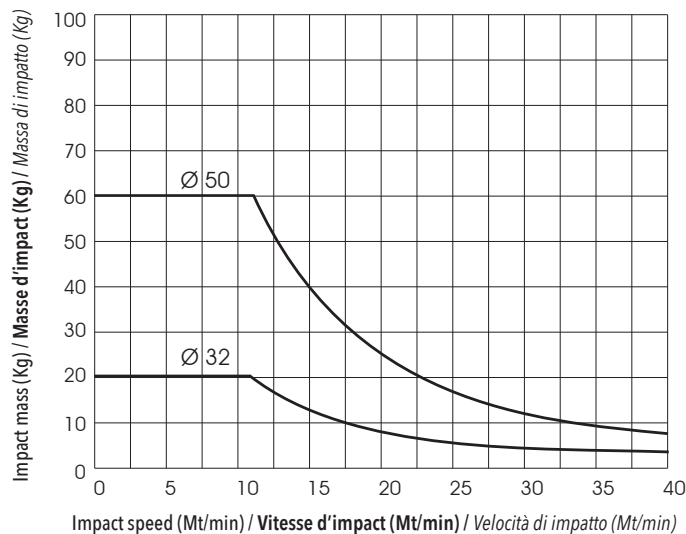

OPERATING / **FONCTIONNEMENT** / *FUNZIONAMENTO*

Smooth rod / **Tige lisse** / *Stelo liscio*

- 1 - Component P is blocked / **Le composant P est bloqué** / *Il pezzo P è bloccato.*
- 2 - By supplying air to the stopper cylinder, Component P is free to move / **En fournissant l'air au vérin stoppeur, le composant P est libre de se déplacer** / *Alimentando il cilindro stopper, il pezzo P si libera.*
- 3 - By removing air supply from stopper cylinder, rod extends to lock the next Component / **En retirant l'alimentation en air du vérin stoppeur, la tige s'étend pour verrouiller le composant suivant** / *Togliendo l'alimentazione del cilindro stopper, lo stelo si estende per fermare il pezzo successivo*

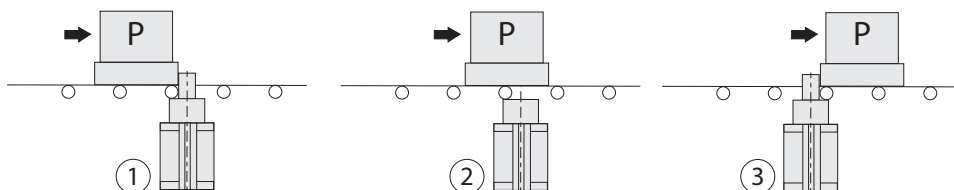

Rod with roller / **Tige avec rouleau** / *Stelo con rullino*

- 1 - Component P is blocked / **Le composant P est bloqué** / *Il pezzo P è bloccato.*
- 2 - By supplying air to the stopper cylinder, Component P is free to move / **En fournissant l'air au vérin stoppeur, le composant P est libre de se déplacer** / *Alimentando il cilindro stopper, il pezzo P si libera.*
- 3 - By removing air supply from stopper cylinder, the roller touches the conveyor belt / **En supprimant l'alimentation en air du vérin stoppeur, le rouleau touche la bande transporteuse** / *Togliendo l'alimentazione la rotella si appoggia al nastro trasportatore*
- 4 - Once that component P passes by, rod extends to lock the next Component / **Une fois que le composant P passe, la tige s'étend pour verrouiller le composant suivant** / *Al passaggio del pezzo P, lo stelo si estende per fermare il pezzo successivo*

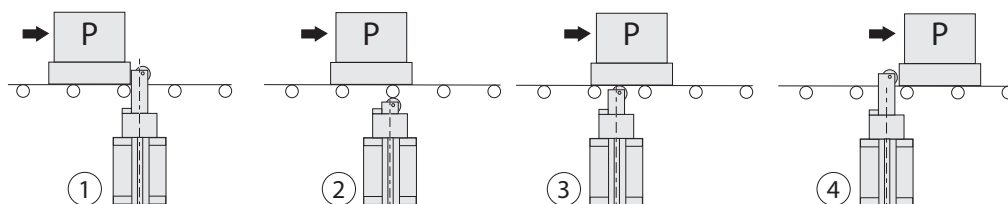

Smooth rod / **Tige lisse** / *Stelo liscio*
Ø 32 mm

ST0101032020

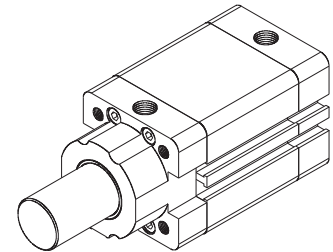
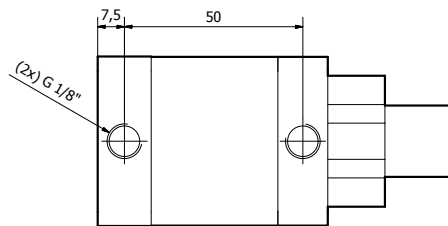
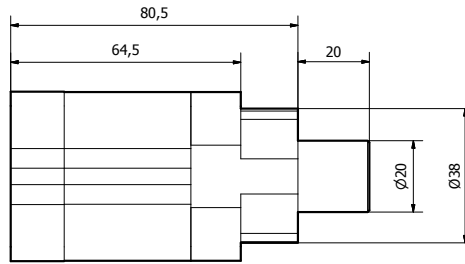
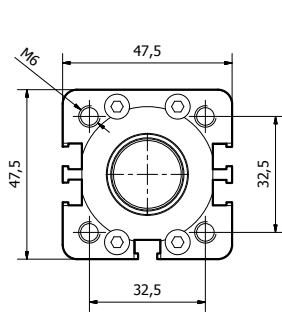

Rod with roller / **Tige avec rouleau** / *Stelo con rullino*
Ø 32 mm

ST0103032020

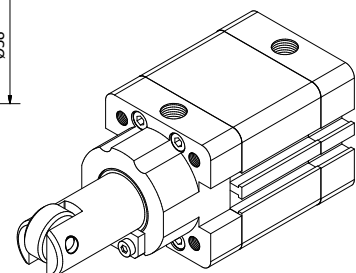
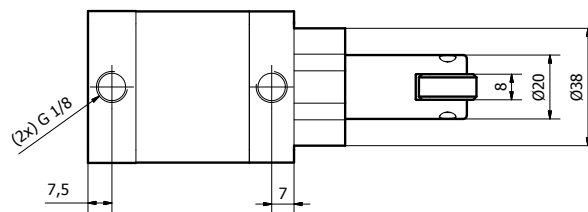
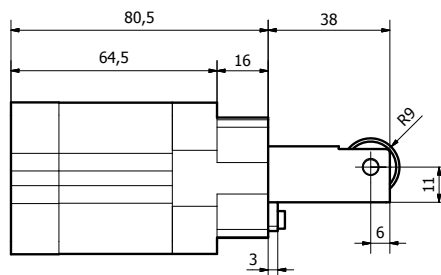
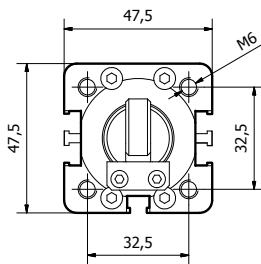

Smooth rod / **Tige lisse** / *Stelo liscio*
Ø 50 mm

ST0101050030

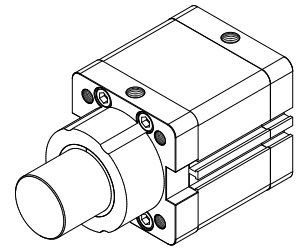
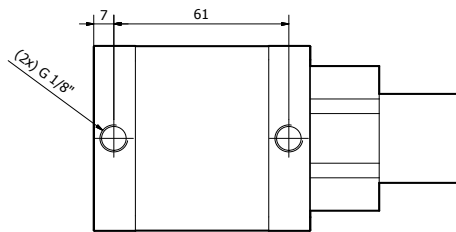
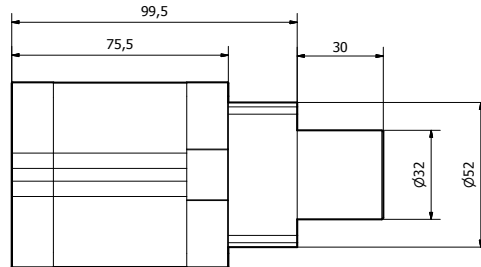
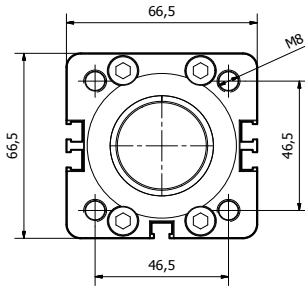

Rod with roller / **Tige avec rouleau** / *Stelo con rullino*
Ø 50 mm

ST0103050030

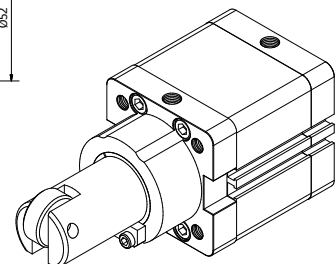
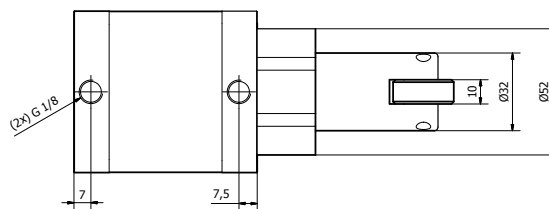
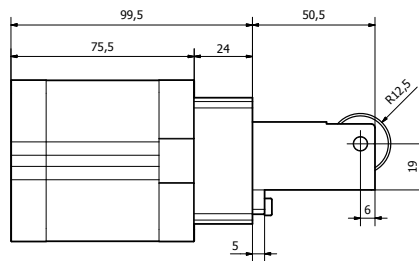
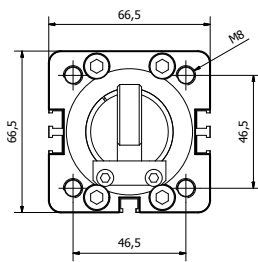

T SWITCH
CAPTEUR EN T
SENSORE AT

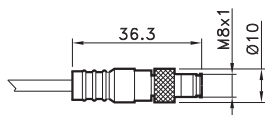
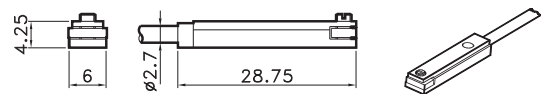

4= black / **noire** / nero
1= brown / **brun** / marrone
3= blue / **bleu** / azzurro

CODE

AR4023010	REED (MT.2,5) / REED (MT.2,5) / REED (MT.2,5)
AR4023020	HALL (MT.2,5) / HALL (MT.2,5) / HALL (MT.2,5)
AR4023110	REED + M8 (CM 30) / REED + M8 / REED + M8 (CM 30)
AR4023120	HALL + M8 (CM 30) / HALL + M8 / HALL + M8 (CM 30)

For technical data see page 1.62

Pour les données techniques, voir page 1.62

Per i dati tecnici vedere pag. 1.62